

Features

- Low On-Resistance: $R_{DS(ON)}$
- Low Gate Threshold Voltage
- Low Input Capacitance
- Fast Switching Speed
- Low Input/Output Leakage
- **Lead Free/RoHS Compliant (Note 2)**
- **Qualified to AEC-Q101 Standards for High Reliability**

Mechanical Data

- Case: SOT-23
- Case Material: Molded Plastic. UL Flammability Classification Rating 94V-0
- Moisture Sensitivity: Level 1 per J-STD-020C
- Terminals: Solderable per MIL-STD-202, Method 208
- Lead Free Plating (Matte Tin Finish annealed over Alloy 42 leadframe).
- Terminal Connections: See Diagram
- Marking Information: See Page 3
- Ordering Information: See Page 3
- Weight: 0.008 grams (approximate)

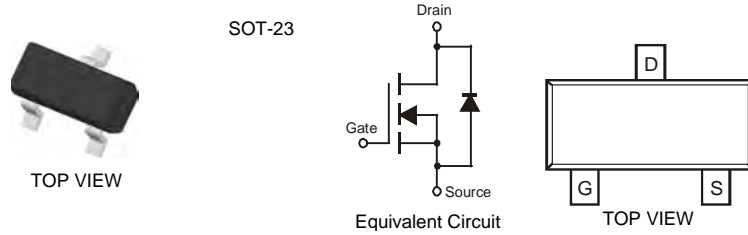

Maximum Ratings @ $T_A = 25^\circ\text{C}$ unless otherwise specified

Characteristic	Symbol	Value	Units
Drain-Source Voltage	V_{DSS}	60	V
Drain-Gate Voltage $R_{GS} \leq 1.0M\Omega$	V_{DGR}	60	V
Gate-Source Voltage	V_{GSS}	±20	V
		±40	
Drain Current (Note 1)	I_D	115	mA
		73	
		800	

Thermal Characteristics @ $T_A = 25^\circ\text{C}$ unless otherwise specified

Characteristic	Symbol	Value	Units
Total Power Dissipation (Note 1)	P_d	300	mW
Derating above $T_A = 25^\circ\text{C}$		2.4	mW/ $^\circ\text{C}$
Thermal Resistance, Junction to Ambient	$R_{\theta JA}$	417	$^\circ\text{C}/\text{W}$
Operating and Storage Temperature Range	T_j, T_{STG}	-55 to +150	$^\circ\text{C}$

- Notes:
1. Device mounted on FR-4 PCB 1.0 x 0.75 x 0.062 inch pad layout as shown on Diodes, Inc. suggested pad layout AP02001, which can be found on our website at <http://www.diodes.com/datasheets/ap02001.pdf>.
 2. No purposefully added lead.

Electrical Characteristics @ $T_A = 25^\circ\text{C}$ unless otherwise specified

Characteristic	Symbol	Min	Typ	Max	Unit	Test Condition
OFF CHARACTERISTICS (Note 3)						
Drain-Source Breakdown Voltage	BV_{DSS}	60	70	—	V	$V_{GS} = 0V, I_D = 10\mu A$
Zero Gate Voltage Drain Current	I_{DSS}	—	—	1.0 500	μA	$V_{DS} = 60V, V_{GS} = 0V$ @ $T_C = 25^\circ\text{C}$ @ $T_C = 125^\circ\text{C}$
Gate-Body Leakage	I_{GSS}	—	—	± 10	nA	$V_{GS} = \pm 20V, V_{DS} = 0V$
ON CHARACTERISTICS (Note 3)						
Gate Threshold Voltage	$V_{GS(th)}$	1.0	—	2.5	V	$V_{DS} = V_{GS}, I_D = 250\mu A$
Static Drain-Source On-Resistance	$R_{DS(ON)}$	—	3.2 4.4	7.5 13.5	Ω	$V_{GS} = 5.0V, I_D = 0.05A$ $V_{GS} = 10V, I_D = 0.5A$
On-State Drain Current	$I_{D(ON)}$	0.5	1.0	—	A	$V_{GS} = 10V, V_{DS} = 7.5V$
Forward Transconductance	g_{FS}	80	—	—	mS	$V_{DS} = 10V, I_D = 0.2A$
DYNAMIC CHARACTERISTICS						
Input Capacitance	C_{iss}	—	22	50	pF	$V_{DS} = 25V, V_{GS} = 0V$ $f = 1.0\text{MHz}$
Output Capacitance	C_{oss}	—	11	25	pF	
Reverse Transfer Capacitance	C_{rss}	—	2.0	5.0	pF	
SWITCHING CHARACTERISTICS						
Turn-On Delay Time	$t_{D(ON)}$	—	7.0	20	ns	$V_{DD} = 30V, I_D = 0.2A,$ $R_L = 150\Omega, V_{GEN} = 10V,$ $R_{GEN} = 25\Omega$
Turn-Off Delay Time	$t_{D(OFF)}$	—	11	20	ns	

Notes: 3. Short duration pulse test used to minimize self-heating effect.

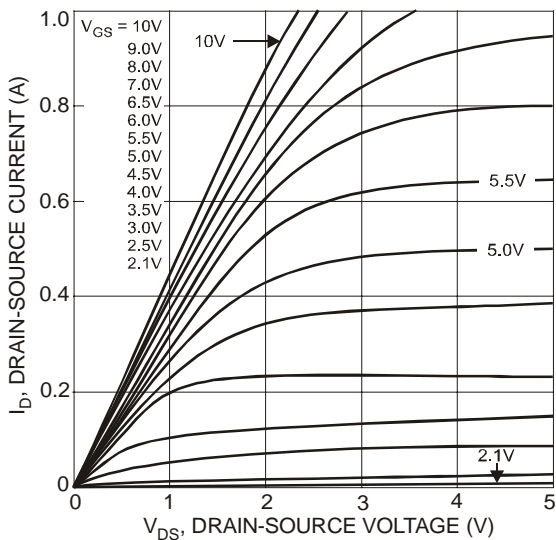

Fig. 1 On-Region Characteristics

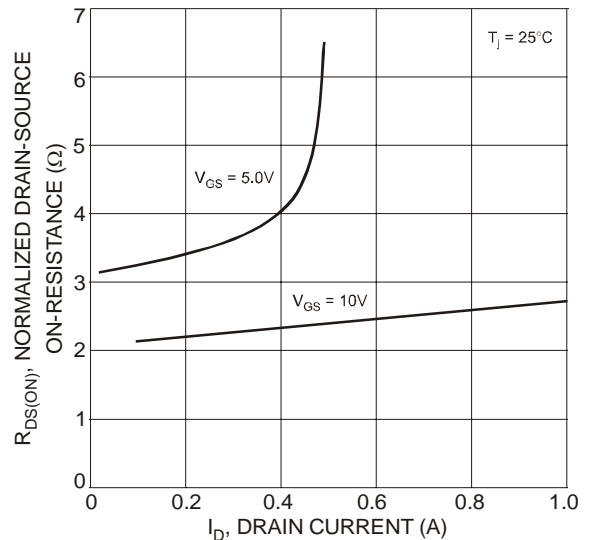

Fig. 2 On-Resistance vs. Drain Current

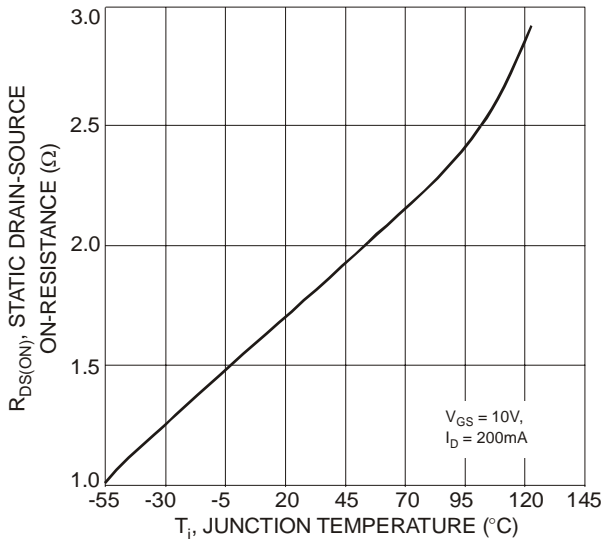

Fig. 3 On-Resistance vs. Junction Temperature

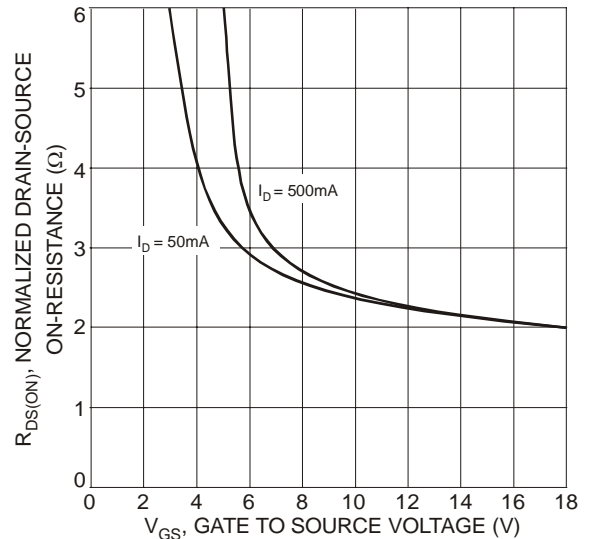
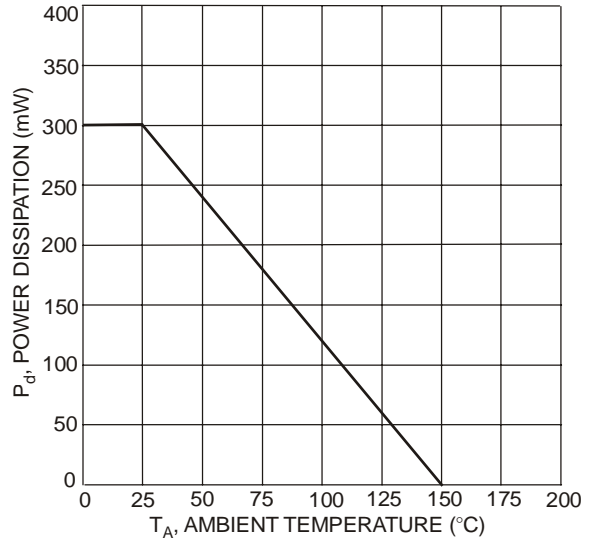
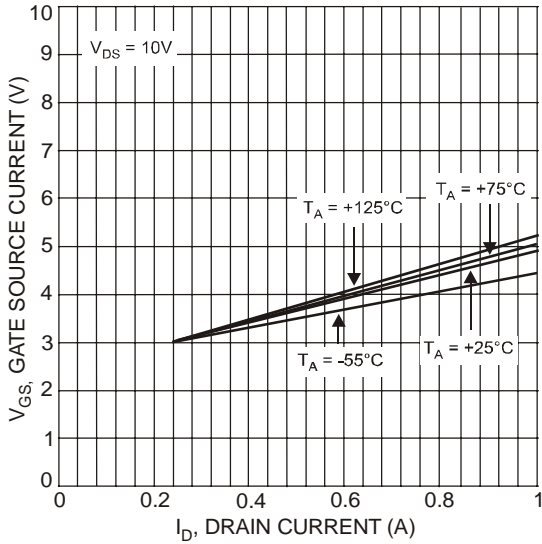

Fig. 4 On-Resistance vs. Gate-Source Voltage



Ordering Information (Note 4)

Part Number	Case	Packaging
2N7002-7-F	SOT-23	3000/Tape & Reel

Notes: 4. For packaging details, go to our website at <http://www.diodes.com/datasheets/ap02007.pdf>.

Marking Information

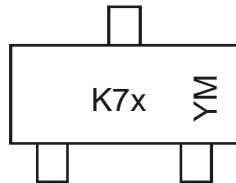

K7x = Product Type Marking Code, e.g. K72
 YM = Date Code Marking
 Y = Year ex: N = 2002
 M = Month ex: 9 = September

Date Code Key

Year	1998	1999	2000	2001	2002	2003	2004	2005	2006	2007	2008	2009	2010	2011	2012
Code	J	K	L	M	N	P	R	S	T	U	V	W	X	Y	Z

Month	Jan	Feb	Mar	Apr	May	Jun	Jul	Aug	Sep	Oct	Nov	Dec
Code	1	2	3	4	5	6	7	8	9	O	N	D

Package Outline Dimensions

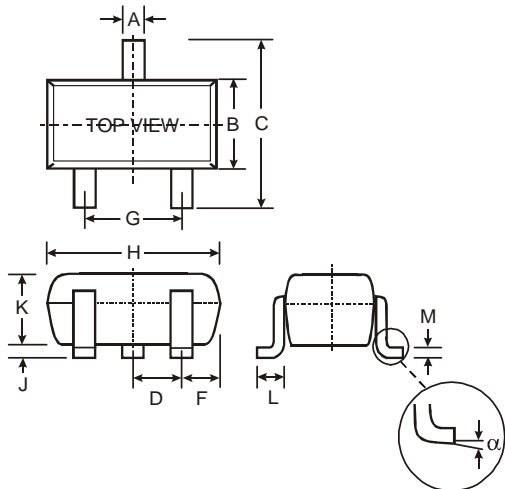

SOT-23		
Dim	Min	Max
A	0.37	0.51
B	1.20	1.40
C	2.30	2.50
D	0.89	1.03
F	0.45	0.60
G	1.78	2.05
H	2.80	3.00
J	0.013	0.10
K	0.903	1.10
L	0.45	0.61
M	0.085	0.180
α	0 $^\circ$	8 $^\circ$
All Dimensions in mm		

Suggested Pad Layout

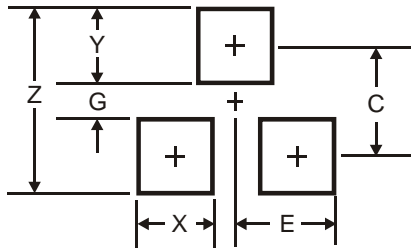

Dimensions	Value (in mm)
Z	3.4
G	0.7
X	0.9
Y	1.4
C	2.0
E	0.9

IMPORTANT NOTICE

Diodes Incorporated and its subsidiaries reserve the right to make modifications, enhancements, improvements, corrections or other changes without further notice to any product herein. Diodes Incorporated does not assume any liability arising out of the application or use of any product described herein; neither does it convey any license under its patent rights, nor the rights of others. The user of products in such applications shall assume all risks of such use and will agree to hold Diodes Incorporated and all the companies whose products are represented on our website, harmless against all damages.

LIFE SUPPORT

Diodes Incorporated products are not authorized for use as critical components in life support devices or systems without the expressed written approval of the President of Diodes Incorporated.